

CITY CRANE F15-15C

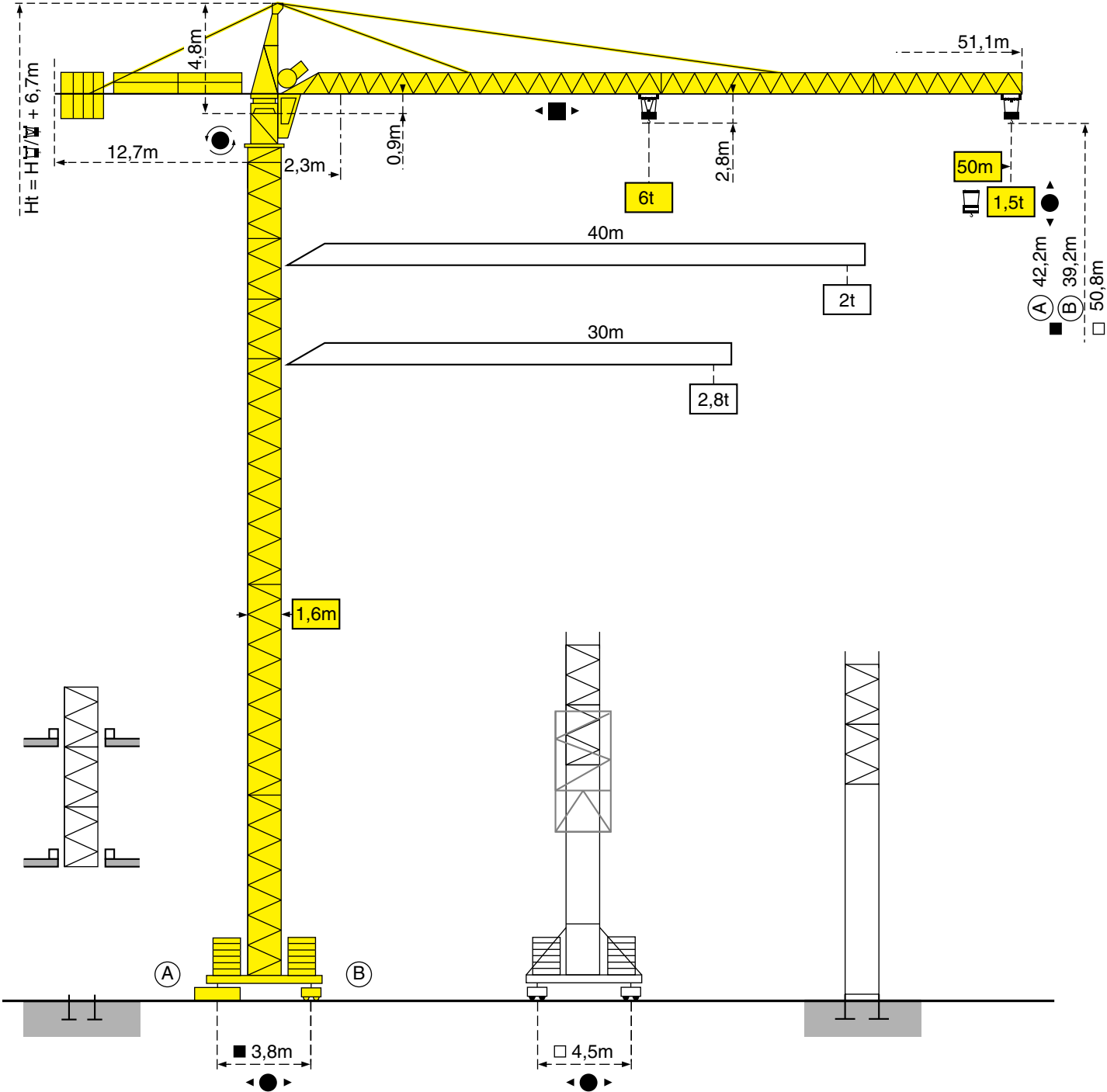

CITY CRANE F15-15C



Mats - Maste - Masts - Mástil - Torre



□ 1,6m

$$H_{\text{M}} = H_{\text{C}} / \text{M} + 0,7 \text{ m}$$

Flèche - Ausleger - Jib
Flecha - Braccio
30m ⇒ 50m

ZC 485

ZC 486

PA 484

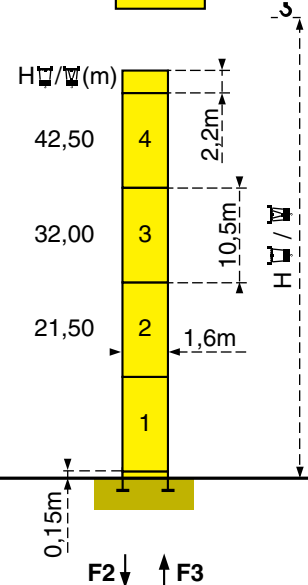
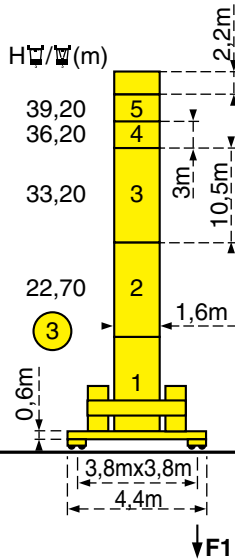
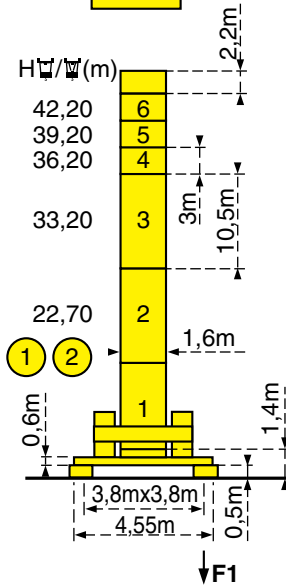

F1	● 51t	■ 64t
----	-------	-------

⊕	27t
---	-----

F1	● 48t	■ 55t
----	-------	-------

⊕	28t
---	-----

F2	● 71t	■ 92t
----	-------	-------

F3	● 47t	■ 71t
----	-------	-------

⊕	24t
---	-----

Mats - Maste - Masts - Mástil - Torre



□ 1,6m

$$H_{\text{M}} = H_{\text{C}} / \text{M} + 0,7 \text{ m}$$

Flèche - Ausleger - Jib
Flecha - Braccio
30m ⇒ 50m

PA 470

SB 469

BA 45A

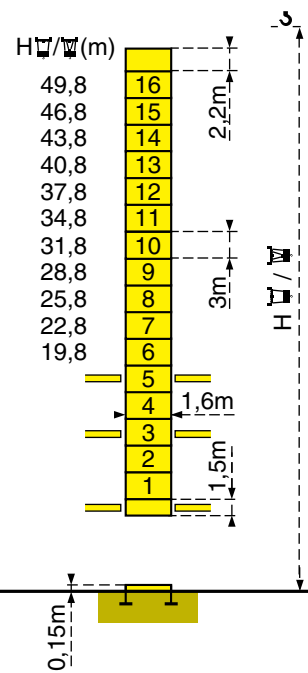
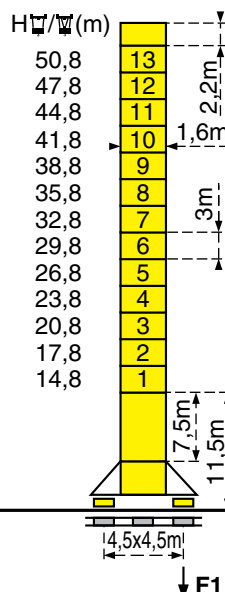
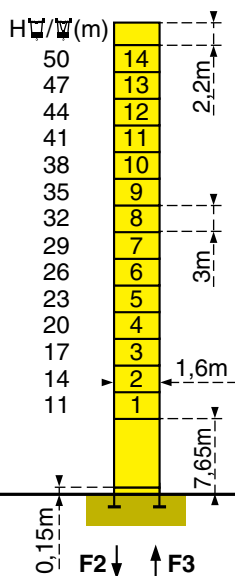

F2	● 80t	■ 132t
----	-------	--------

F3	● 56t	■ 111t
----	-------	--------

⊕	34t
---	-----

F1	● 60t	■ 87t
----	-------	-------

⊕	41t
---	-----

Voir ci-contre
Siehe nebenstehend
See opposite
Ver página opuesta
Vedi pagina accanto

F = Réactions - Eckdrücke - Reactions - Reacciones - Reazioni

Courbes de charges - Lastkurven - Load diagrams - Curvas de cargas - Curve di carico



Flèche Ausleger Jib Flecha Braccio

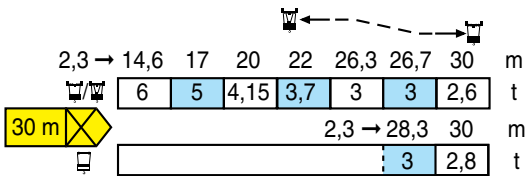
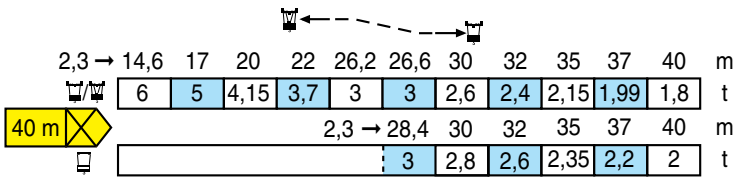
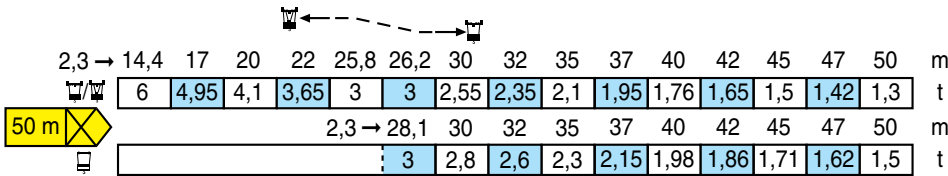

- Chariot standard 2/4 brins. (En cas d'utilisation déduire 0,1 t aux charges).
- Chariot optionnel 2 brins uniquement.
- Standardlaufkatze 2/4 Stränge. (Bei Einsatz von ist 0,1 t der Lasten von abzuziehen).
- Laufkatze in Sonderausführung mit nur 2 Strängen.
- Standard trolley 2/4 fall. (When using subtract 0,1 t from the loads).
- Optional trolley 2 fall only.
- Carrellino standard tiro in 2a/4a (Usando tiro in 4a togliere 0,1 t ai valori di carico).
- Carrellino in opzione solo con tiro in 2a.
- Carro standard 2/4 ramales. (En caso de utilizacion quitar 0,1 t de las cargas).
- Carro opcional en 2 ramales solamente.

ZC

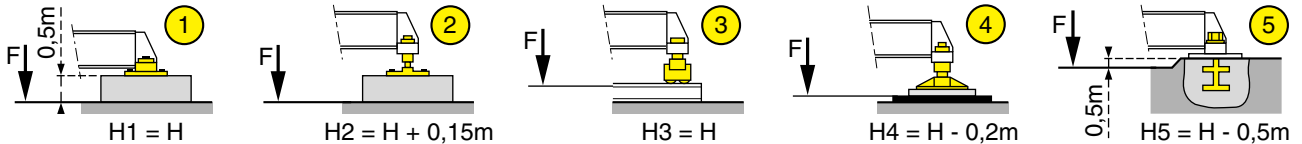



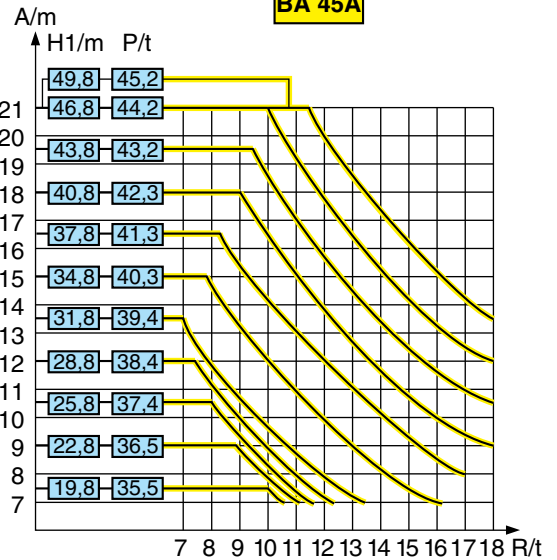
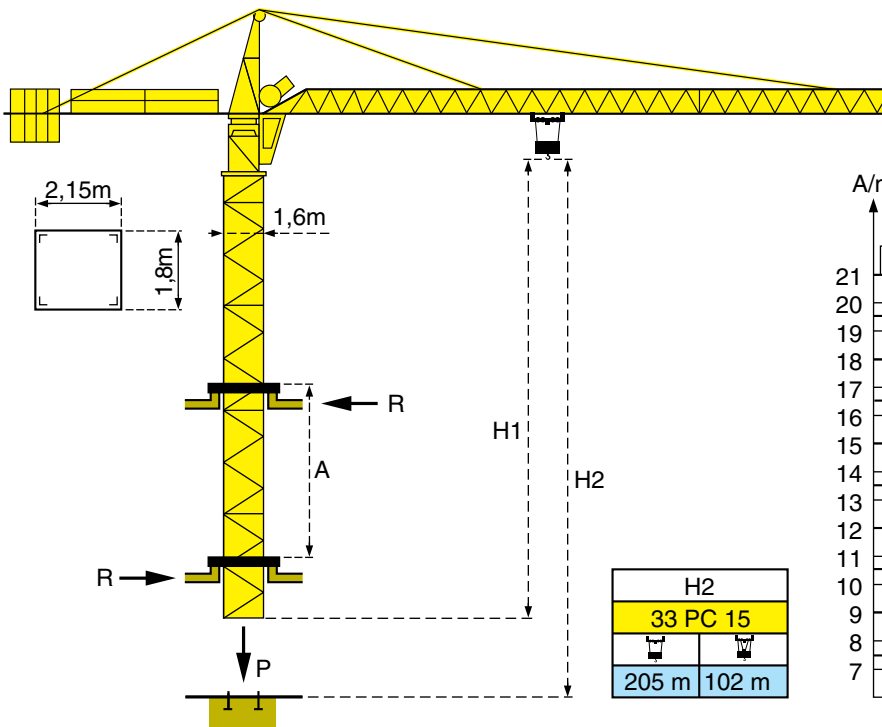











Télescopage sur dalles - Kletterkrane im Gebäude - Climbing crane Telescopage gruas trepadoras - Gru in cavedio

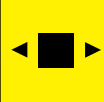

- A Distance entre cadres
- A Abstand zwischen den Rahmen
- A Distance between collars
- A Distancia entra marcos
- A Distanza fra i telai
- H1 Hauteur grue
- H1 Kranhöhe
- H1 Crane height
- H1 Altura grúa
- H1 Altezza grua
- P Poids de la grue (en service)
- P Krangewicht (in Betrieb)
- P Crane weight (in service)
- P Peso de la grúa (en servicio)
- P Peso della gru (in servizio)
- R Réaction horizontale
- R Horizontalkräfte
- R Horizontal reaction
- R Reaccion horizontal
- R Reazione orizzontale

- En service
- Hors service
- In Betrieb
- Ausser Betrieb
- In service
- Out of service
- En servicio
- Fuera de servicio
- In servizio
- Fuori servizio
- A vide sans lest avec flèche et hauteur maximum.
- Ohne Last und Ballast mit Maximalausleger und Maximalhöhe.
- Without load and ballast with longest jib and maximum height.
- Sin carga, sin lastre con flecha y altura máximas.
- A vuoto senza zavorra e con braccio massimo e altezza massima.

Mécanismes - Antriebe - Mechanisms - Mecanismos - Meccanismi

				m/min	t		ch -PS hp	kW
Levage Heben Hoisting Elevación Sollevamento	33 PC 15 	     		7	3	410 m > 410 m *	33	24,2
			38,5	3				
			77	1,5				
			3,5	6				
			19	6				
			38,5	3				
Ditribution - Katzfahren - Trolleying Distribución - Distribuzione		4 D3 V3		15 30 58			4	3
Orientation - Schwenken - Slewing Orientación - Rotazione		RCV 80		0 → 0,8			2 x 6	2 x 4,4
Translation Kranfahren Travelling Traslación Traslazione	ZC   SB 469   R ≥ 10 m	RT 224		25			2 x 4	2 x 2,9
		RT 324		12,5 - 25			2 x 7	2 x 5,2
		TCV 449 ARC H ≤ 32,8 m		10 - 50			4 x 6,8	4 x 5
Réseau - Netzstrom - Mains supply - Red - Rete elettrica							380V - 50Hz	
Puissance électrique nécessaire - Anschlusswert - Necessary electric power Potencia eléctrica necesaria - Potenza elettrica necessaria							33 PC 15 : 50 kVA	
Groupe électrogène - Stromaggregat - Generator set - Grupo electrogeno - Gruppo elettrogeno							*	

*Nous consulter - Auf Anfrage - Consult us - Consultarnos - Consultateci

Conforme à la directive CEE 84/534 sur le niveau acoustique - Gemäss EWG-Richtlinie 84/534 Schall- Leistungspegel
 In compliance with the EEC 84/534 Instruction on noise level - Conforme con la direttiva CEE 84/534 sobre el nivel acustico
 Conforme colla direttiva CEE 84/534 sul livello acustico



NF E 52081 - 82

Copyright.Reproduction interdite © POTAIN 1992

POTAIN 

GRUPE EGRIS INDUSTRIES

18.Rue de Charbonnières, B.P. 173-F 69132 ECULLY Cedex
 Tél. 72.20.20.20 - Télex 375 213 - Fax 72.20.20.00

POTAIN GmbH Deutschland Tel : 06.105.704.0
 POTAIN U.K. Great Britain Tel : 0895.44.52.61
 Simma POTAIN Italia Tel : 02.97.96.71
 POTAIN Portugal Portugal Tel : 02.968.08.89

CITY CRANE F15 - 15C

Réf. 1992.42 LFM 2

Courtesy of Crane.Market

Modifiche riservate

Modificaciones reservadas

Subject to modification

Änderungen vorbehalten

Modifications réservées

Printed in France

Réalisation SODIPE